

 = Afrijdbaar element 3 x

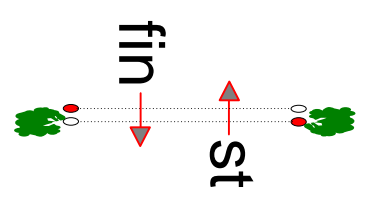

BS

H 3

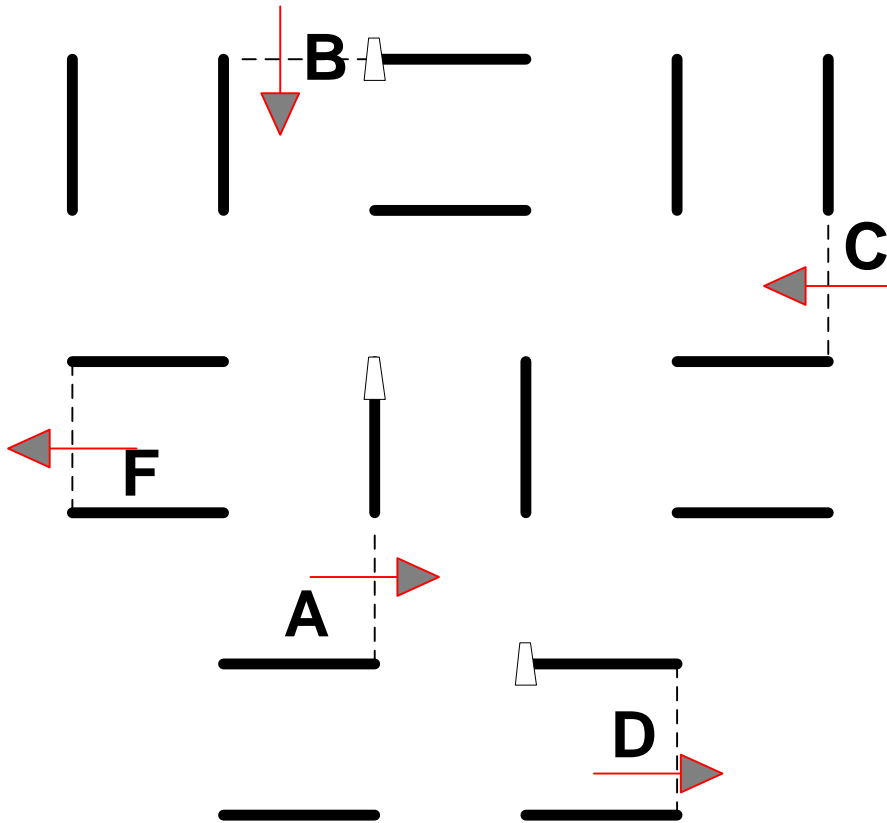
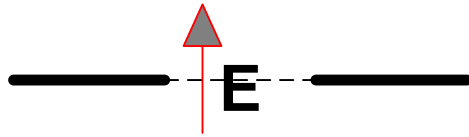

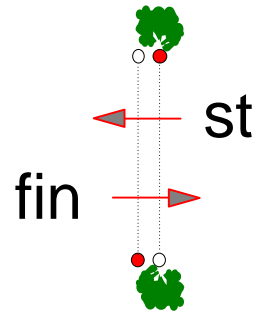

 = Afrijdbaar element 3 x

BS

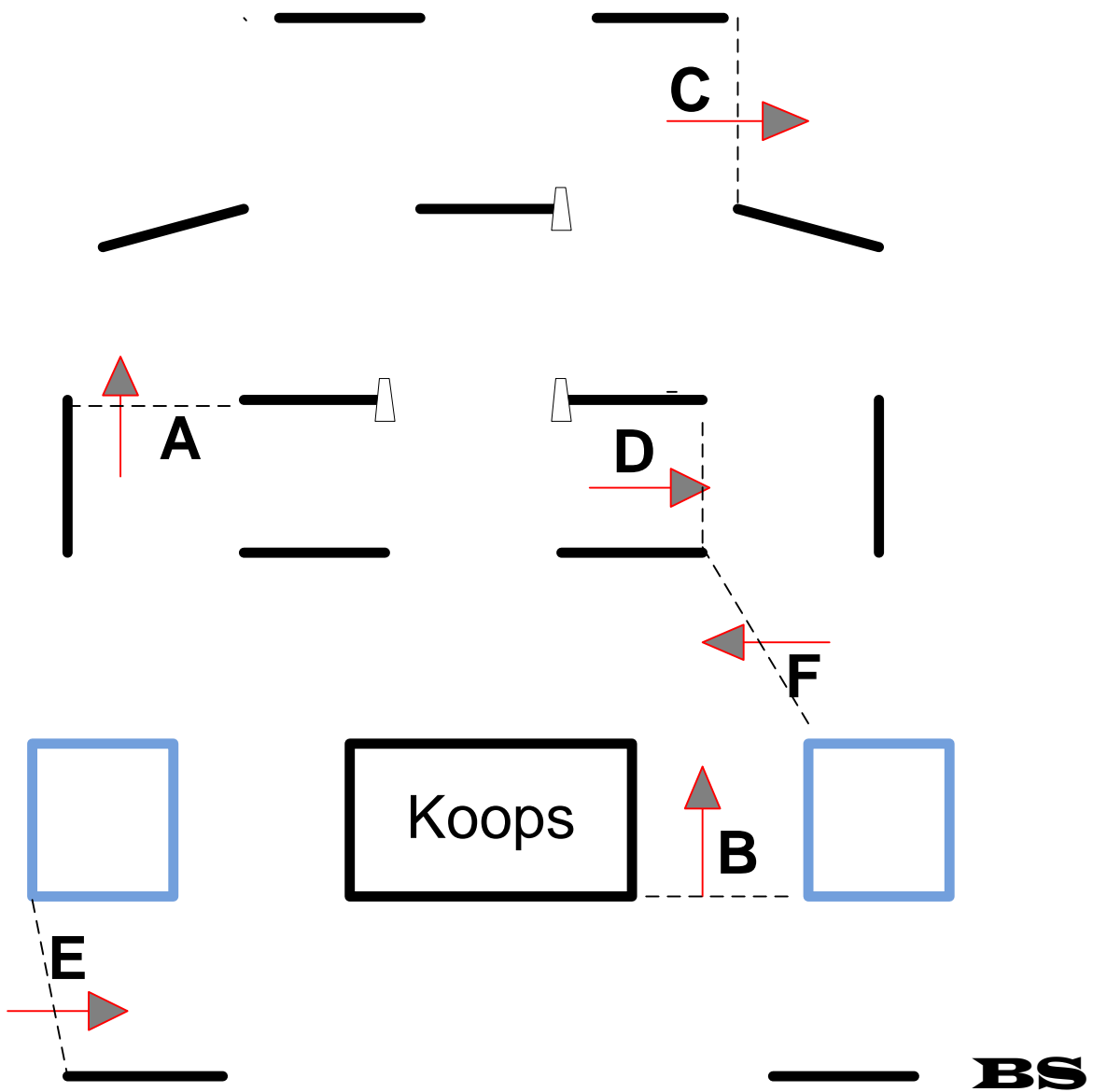
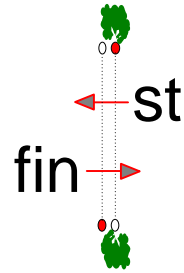

H 4



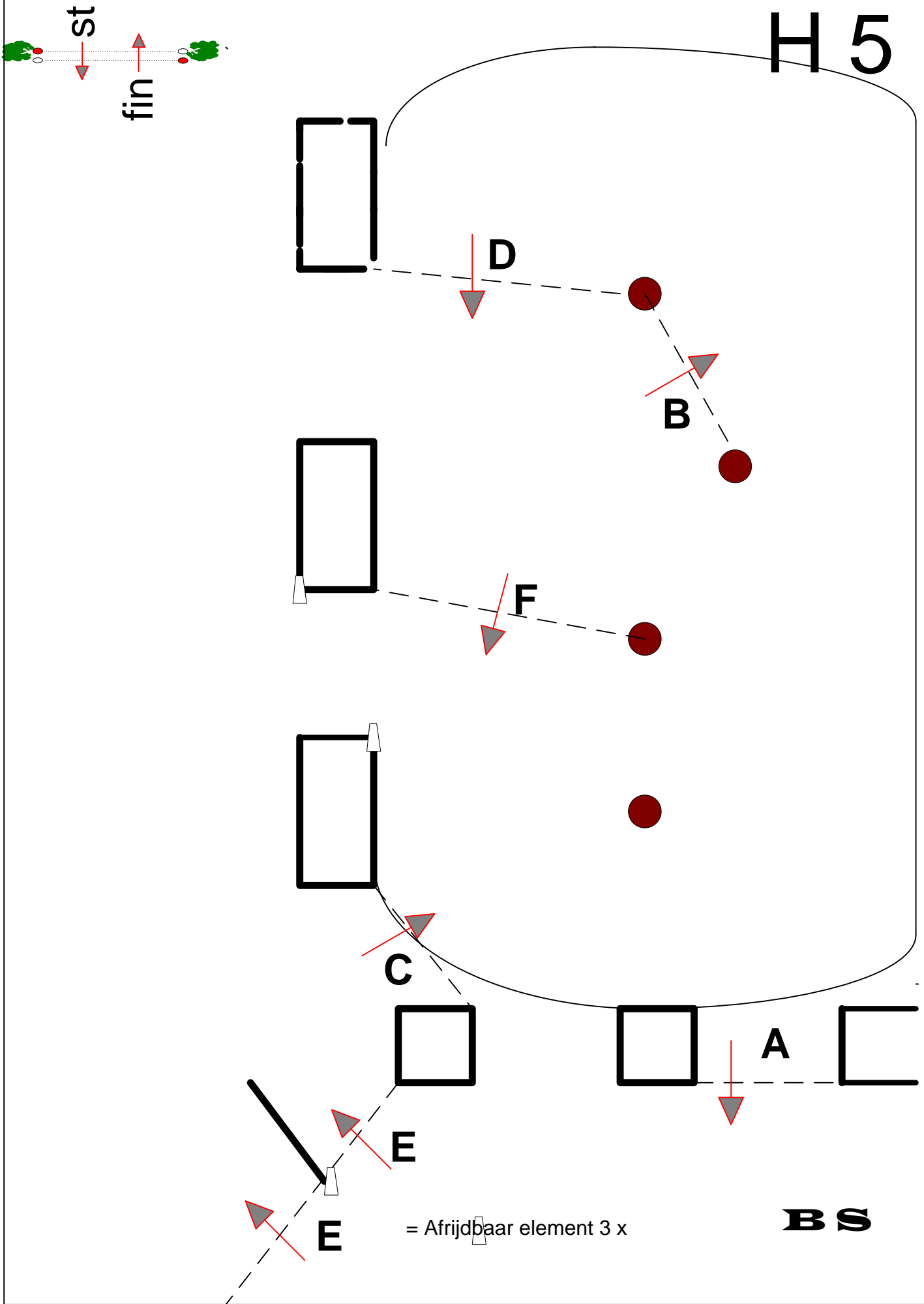

 = Afrijdbaar element 3 x

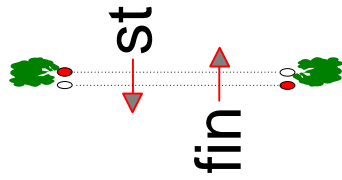

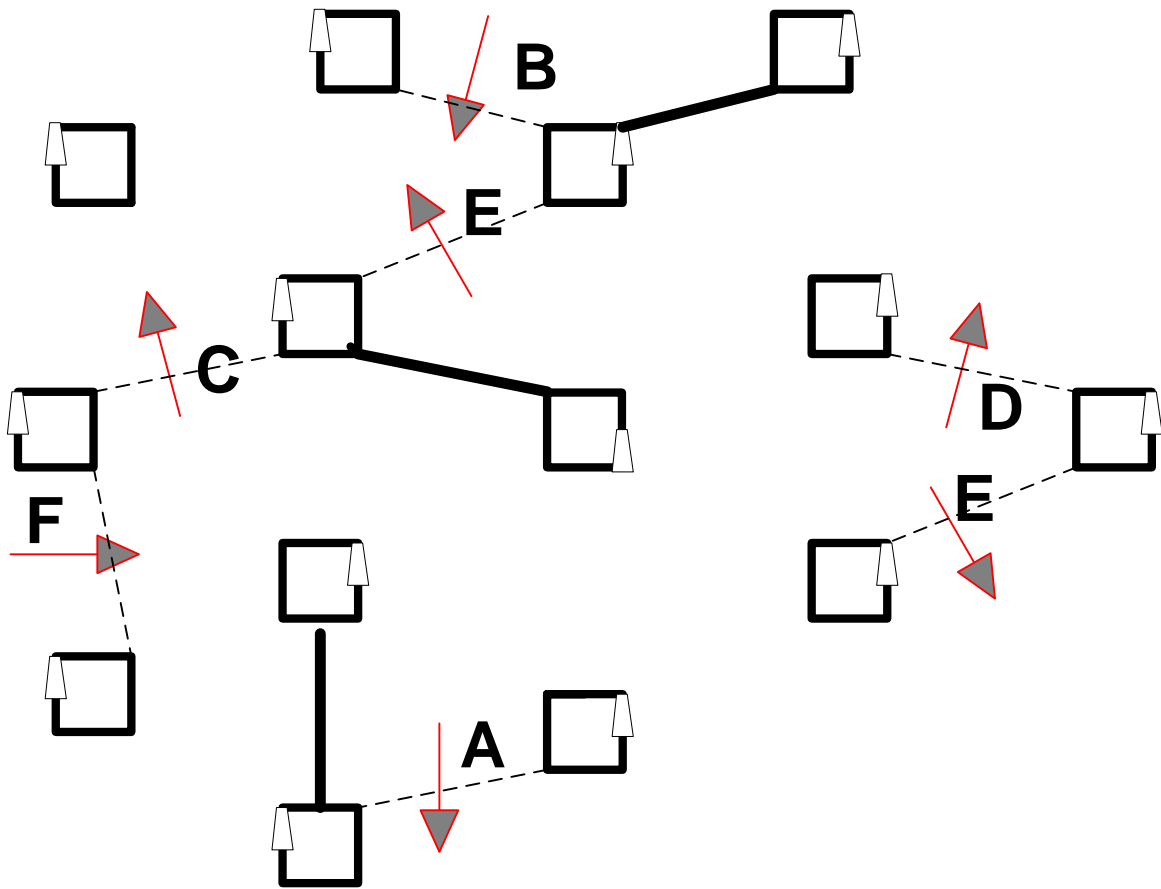

H 6



 = Afrijdbaar element 14 x

BS